

# **User Manual**

**TDS3LIM**  
**Limit Test**  
**Application Module**  
**071-0934-00**



071093400

Copyright © Tektronix, Inc. All rights reserved.

Tektronix products are covered by U.S. and foreign patents, issued and pending. Information in this publication supercedes that in all previously published material. Specifications and price change privileges reserved.

Tektronix, Inc., P.O. Box 500, Beaverton, OR 97077

TEKTRONIX, TEK, TEKPROBE, and Tek Secure are registered trademarks of Tektronix, Inc.

DPX, WaveAlert, and e\*Scope are trademarks of Tektronix, Inc.

## **WARRANTY SUMMARY**

Tektronix warrants that the products that it manufactures and sells will be free from defects in materials and workmanship for a period of one (1) year from the date of shipment from an authorized Tektronix distributor. If a product proves defective within the respective period, Tektronix will provide repair or replacement as described in the complete warranty statement.

To arrange for service or obtain a copy of the complete warranty statement, please contact your nearest Tektronix sales and service office.

EXCEPT AS PROVIDED IN THIS SUMMARY OR THE APPLICABLE WARRANTY STATEMENT, TEKTRONIX MAKES NO WARRANTY OF ANY KIND, EXPRESS OR IMPLIED, INCLUDING WITHOUT LIMITATION THE IMPLIED WARRANTIES OF MERCHANTABILITY AND FITNESS FOR A PARTICULAR PURPOSE. IN NO EVENT SHALL TEKTRONIX BE LIABLE FOR INDIRECT, SPECIAL OR CONSEQUENTIAL DAMAGES.

## Contacting Tektronix

Phone	1-800-833-9200*
Address	Tektronix, Inc. Department or name (if known) 14200 SW Karl Braun Drive P.O. Box 500 Beaverton, OR 97077 USA
Web site	www.tektronix.com
Sales support	1-800-833-9200, select option 1*
Service support	1-800-833-9200, select option 2*
Technical support	Email: techsupport@tektronix.com 1-800-833-9200, select option 3* 1-503-627-2400  6:00 a.m. – 5:00 p.m. Pacific time

- 
- \* This phone number is toll free in North America. After office hours, please leave a voice mail message. Outside North America, contact a Tektronix sales office or distributor; see the Tektronix web site for a list of offices.

## Contents

Safety Summary	2
Installing the Application Module	5
Limit Testing Concepts	5
TDS3LIM Overview	8
Accessing Limit Test Menus	9
Creating a Limit Test Template	11
Selecting a Limit Test Input	14
Selecting Limit Test Responses	15
Starting Limit Testing	16
TDS3LIM Conventions	17
Menus	19

## Safety Summary

To avoid potential hazards, use this product only as specified. While using this product, you may need to access other parts of the system. Read the *General Safety Summary* in other system manuals for warnings and cautions related to operating the system.

### Preventing Electrostatic Damage

 **CAUTION.** *Electrostatic discharge (ESD) can damage components in the oscilloscope and its accessories. To prevent ESD, observe these precautions when directed to do so.*

**Use a Ground Strap.** Wear a grounded antistatic wrist strap to discharge the static voltage from your body while installing or removing sensitive components.

**Use a Safe Work Area.** Do not use any devices capable of generating or holding a static charge in the work area where you install or remove sensitive components. Avoid handling sensitive components in areas that have a floor or benchtop surface capable of generating a static charge.

**Handle Components Carefully.** Do not slide sensitive components over any surface. Do not touch exposed connector pins. Handle sensitive components as little as possible.

**Transport and Store Carefully.** Transport and store sensitive components in a static-protected bag or container.

### Manual Storage

The oscilloscope front cover has a convenient place to store this manual.

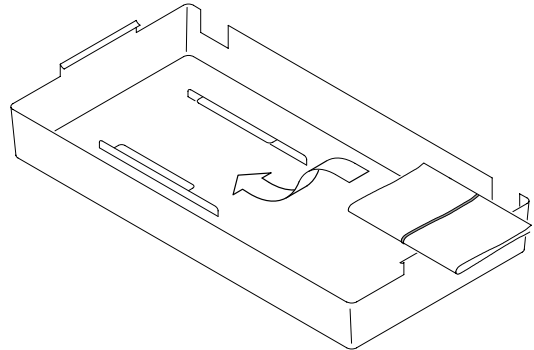

## Installing the Application Module

Please refer to the *TDS3000 & TDS3000B Series Application Module Installation Manual* for information on installing the application module.

## Limit Testing Concepts

Limit testing is the ability to compare an active signal with a template waveform. The following figure shows an active waveform (dark sine wave) being compared to a template waveform (shaded area).

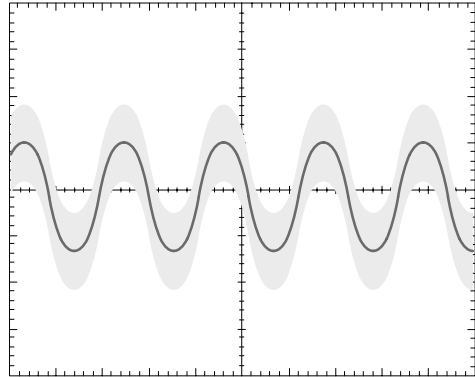

Any part of the active waveform that exceeds the template waveform's envelope is a limit test waveform violation, which the oscilloscope highlights. You can set the oscilloscope to respond to a limit test violation by stopping limit testing, emitting a beep, and so on. The following figure shows the highlighted (black) part of the active waveform that exceeds the limit test envelope.

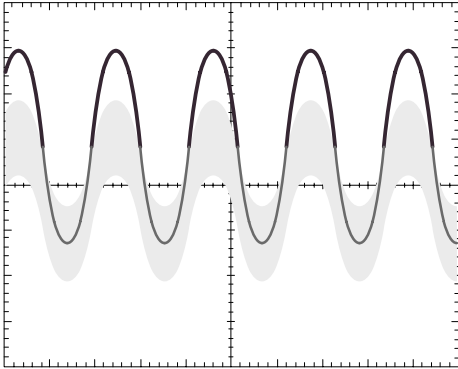

A template is an envelope waveform that consists of minimum/maximum (min/max) pairs of sample points. Template envelope waveforms created from 500 point source waveforms contain 250 min/max pairs; Template envelope waveforms created from 10K point waveforms contain 5000 min/max pairs.

The following figure represents how the oscilloscope creates the template waveform limit test envelope from user-entered vertical and horizontal division units. Division units are referenced to graticule divisions, where 1 major division contains 1000 millidivisions, or mdivs. The minimum mdiv unit is 20, which equals one screen pixel.

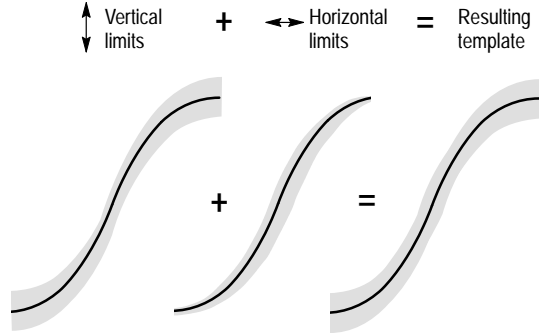

When a source waveform is compared with an envelope waveform, each source waveform sample point value is compared to the vertical and horizontal min/max values of the corresponding envelope waveform sample point. Any source waveform data point that is not equal to or within the corresponding template envelope min/max values is a violation.

## TDS3LIM Overview

This section provides an overview of the TDS3LIM Limit Test application module features, and describes how to access the limit test functions.

You can do the following limit test tasks with the TDS3LIM application module:

- Create and save up to four template waveforms in reference memory. You can create a template waveform from either an active input signal or from a saved reference waveform.
- Select the channel to compare to the template. You can compare multiple channels to a single template waveform, compare each channel to a single template waveform, or any combination of the above.
- Set the oscilloscope to respond to waveforms that exceed the template limits. You can set the oscilloscope to stop acquiring waveforms, save the failed waveform data to a file, emit a beep, save the screen image to the hard copy device, or any combination of the above.

## Accessing Limit Test Menus

You access the TDS3LIM limit test controls from either the limit test QuickMenu or from the Applications menu. The QuickMenu displays a single bottom and side menu that provides quick access to all limit test functions.

To display the limit test QuickMenu, do the following steps:

- 1 Push the **QUICKMENU** panel button.
- 2 Push the **Menu** bottom button to select **Limit Test**. The oscilloscope displays the limit test bottom and side menu items.



The Applications menus provide multiple bottom and side menu items that contain all limit test controls and settings. The menu items contain text or graphics that more fully describe the function of each menu item.

To display the limit test menu items in the Applications menu, do the following steps:

- 1 Push the **UTILITY** panel button.
- 2 Push the **System** bottom button to select **Apps**.
- 3 Push the **Module** button to select **Limit Test**. The bottom and side menus change to show the limit test functions.

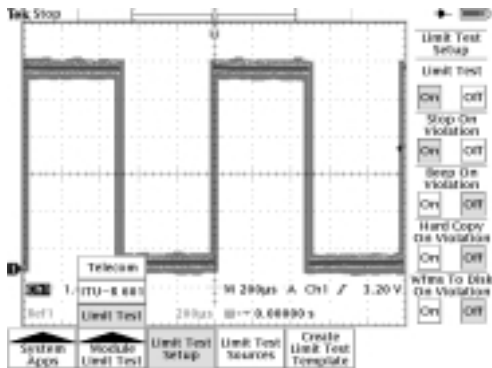

## Creating a Limit Test Template

You must create a limit test waveform template before you can do limit testing. The TDS3LIM lets you easily create a template by using a known good waveform (active or reference), using the vertical and horizontal division units to graphically define the template waveform envelope, and saving the template to reference waveform memory (Ref1 - Ref4).

To use an active waveform to create a limit test template, do the following steps:

- 1 Connect a known good waveform to any one of the oscilloscope inputs.
- 2 Set the oscilloscope horizontal and vertical controls to optimize the waveform size and position on the screen.

**NOTE.** Use the Average acquisition mode to create a smoother, cleaner template waveform. You can also save the oscilloscope settings from step 2 into setup memory so that later on you can quickly reload the oscilloscope settings to correctly display the incoming waveform for limit testing.

**NOTE.** Use Envelope acquisition mode in order to create template waveforms that include occasional overshoots.



- 3 Push the **QUICKMENU** panel button.
- 4 Push the **Menu** bottom button to select **Limit Test**. The oscilloscope displays the limit test bottom and side menu items.
- 5 Push the Template **Source/Destination** side button to select the **Source** field; use the general purpose knob to select the channel to which the known good signal is connected (Ch1 - Ch4).  
You can also create a limit test waveform template from a reference waveform by using the general purpose knob to select a reference waveform (Ref1-Ref4).
- 6 Push the **Source/Destination** side button to select the **Destination** field; use the general purpose knob to select the reference memory location where you want to store the template waveform (Ref1 - Ref4).
- 7 Push the **±V Limit** side button to select the template vertical limits field. Use the general purpose knob to set the template waveform envelope vertical limits. Refer to page 6 for an explanation of the limit units.

- 8 Push the **±H Limit** side button to select the horizontal limits field. Use the general purpose knob to set the template waveform envelope horizontal limits. Refer to page 6 for an explanation of the limit units.
- 9 Push the **Store Template** bottom button to create the limit test waveform and save it to the specified reference memory location. If the template reference waveform is currently displayed, the oscilloscope redraws the reference waveform using the newly stored values.
- 10 If the template reference waveform is not currently displayed, push the **CONTROL** bottom button to select **On**. The oscilloscope displays the reference waveform.
- 11 If the template reference waveform does not meet your requirements, repeat steps 7 through 9 to change the template waveform envelope.

## Selecting a Limit Test Input

To select the channel source for comparing with a template, do the following steps (the Limit Test QuickMenu must still be displayed):

- 1 Connect the test waveform to any one of the oscilloscope inputs.
- 2 Set the source waveform horizontal and vertical settings to the same values that were used to create the template.
- 3 Push the **Waveform Comparisons** bottom button for the test waveform channel to select the limit test template (Ref1 - Ref4).

## Selecting Limit Test Responses

When the active waveform exceeds the template waveform's envelope, the oscilloscope can do one or more of the following actions:

- Send a hard copy of the screen to a printer or file
- Save the failing test waveform to a file on the floppy disk
- Emit a beep each time the test waveform fails
- Stop waveform acquisition and display the failing waveform(s)

In the QuickMenu, the **On Violation** side menu uses two buttons, as shown in the following figure.

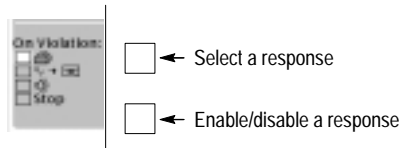

Use the upper menu button to select a response, and then use the lower menu button to enable or disable the selected response. You can select and enable any combination of responses.

## Starting Limit Testing

After setting up a template waveform, selecting a test waveform channel or channels, and selecting the oscilloscope limit test responses, you are ready to start limit testing. To start limit testing, push the **CONTROL** bottom menu button to select **On**. The oscilloscope starts limit testing, and continues testing until a violation occurs, at which time the oscilloscope performs the selected response action.

**NOTE.** *If Stop On Violation is not selected, the oscilloscope performs all selected response tasks (such as emit a beep) and then resumes limit testing.*

**NOTE.** *If the oscilloscope displays an error message stating that limit testing is turned off, check that you have enabled the input signal channels and that there is a valid limit test waveform template or templates in the selected reference memory location(s).*

## TDS3LIM Conventions

The following conventions apply to the TDS3LIM Limit Test application module:

- You do not need to display a reference template waveform to do limit testing.
- Moving a reference template waveform on the display screen does not change the reference template waveform data or the limit test parameters. Limit testing compares active signals to the waveform template data in reference memory.
- When limit test is set to Stop On Violation, the oscilloscope stops signal acquisition and highlights the waveform violations.
- While in Limit Test mode, the WAVEFORM INTENSITY knob controls the limit test violations display decay time. The decay time is the amount of time that the violation highlighting remains on the screen. The range of values is zero seconds to always on (infinity). The Waveform Intensity knob does not affect active signal display intensity while Limit Testing is on.

- If you are using two or more waveform templates at a time in a limit test, all the waveform templates must use the same horizontal time base setting.
- Source waveforms you are testing must be set to the same horizontal and vertical settings used to create the corresponding template waveform(s).
- When limit test is set to Hard Copy On Violation or Save To Disk, the oscilloscope completes the task before processing any other tasks or continuing signal acquisition.
- Save To Disk saves the waveform data using the format specified in the **SAVE/RECALL > Save Waveform > To File** menu. Please check this setting so that you are saving waveform data in your preferred format.
- Turning limit testing on sets the signal acquisition mode to Sample.

## Menus

The following sections list the limit test menus and describe each menu function.

### Limit Test QuickMenu

The Limit Test QuickMenu displays bottom and side menus that provide fast access to all limit test functions on one screen.

#### Limit Test QuickMenu: bottom menu

Menu item	Value	Description
CONTROL	OFF ON	When on, starts limit testing.
WAVEFORM COMPARISONS Ch1, Ch2, Ch3, Ch4  (Ch3, Ch4 on 4-channel models only)	Ref1-Ref4, None	Assigns a reference memory location to a signal input channel. Repeatedly push the menu button to cycle through the selections. Selecting None disables limit testing on that channel.  You can compare each channel to a separate template waveform or compare multiple channels to the same template.

### Limit Test QuickMenu: side menu

Menu item	Value	Description
SETUP: On Violation:	Printer icon Floppy icon Speaker icon Stop	<p>When enabled, sets how the oscilloscope responds to limit test failure.</p> <p>The four response actions to a limit test failure are: send a screen capture to the hard copy device, save the failing waveform data to a file on the floppy drive, emit a beep for each failure, and stop waveform acquisition.</p> <p>This menu uses two side menu buttons. The upper button selects a response in the side menu, and the lower button enables or disables the current selection (see page 15). You can select and enable any combination of responses.</p>

### Limit Test QuickMenu: side menu (cont.)

Menu item	Value	Description
TEMPLATE: Source	Ch1-Ch4, Ref1-Ref4	Sets the waveform source from which to create a limit test template waveform, and the destination reference memory location in which to store the template waveform. Pushing the side menu button toggles between selecting the Source and Destination menu fields. Use the general purpose knob to select the value for each field.
Destination	Ref1-Ref4	
TEMPLATE: $\pm V$ Limit $\pm H$ Limit	0 to 5 div	<p>Sets the vertical and horizontal division units used to create a template waveform envelope. Pushing the side menu button toggles between selecting the <math>\pm V</math> Limit and the <math>\pm H</math> Limit menu fields.</p> <p>Use the general purpose knob to select the value for each field. The minimum increment value is 20 mdiv, or one pixel. Refer to page 6 for an explanation of the template envelope.</p>

## Apps Module Limit Test Menu

The TDS3LIM module adds a limit test menu item to the UTILITY > System > Apps > Module menu. The following table describes the new limit test bottom and side menu functions.

### UTILITY > System > Apps > Module Menu

Bottom	Side	Description
Limit Test Setup	Limit Test On Off	Turns limit testing on or off.
	Stop On Violation On Off	When On, the oscilloscope stops waveform acquisition when there is a limit test failure on any channel. The input waveforms and violations remain displayed on the screen.
	Beep On Violation On Off	When On, the oscilloscope beeps when there is a limit test failure on any channel.
	Hard Copy On Violation On Off	When On, the oscilloscope sends an image of the screen to the hard copy device or floppy file for each occurrence of a limit test violation.

### UTILITY > System > Apps > Module Menu (cont.)

Bottom	Side	Description
Limit Test Setup (cont.)	Wfms To Disk On Violation On Off	When On, the oscilloscope saves the violating waveform(s) data to a file on the floppy disk drive for each occurrence of a limit test violation.
Limit Test Sources	Compare Ch1-Ch4 To Ref1-Ref4, None	Selects which input channel to compare to which limit test template stored in reference memory locations Ref1 through Ref4. Selecting none disables limit testing on that channel. Repeatedly push the side menu button to cycle through the possible selections. You can compare each channel to a separate template waveform, or compare multiple inputs to the same template.

UTILITY > System > Apps > Module Menu (cont.)

Bottom	Side	Description
Create Limit Test template	Template Source	Selects which signal source to use to create the limit test template. Valid sources are channels 1 through 4 and reference waveform memory Ref1 through Ref4.
	Template Destination	Selects which reference memory location to use to store the limit test template. Valid sources are Ref1 through Ref4.
	±V limit ±H Limit	Sets the vertical or horizontal limits used to create a template waveform envelope. Use the general purpose knob to select the limit value. Units are in divisions, and range from zero to five major divisions, in increments of 20 millidivisions (1 pixel). Refer to page 6 for an explanation of the template envelope.

UTILITY > System > Apps > Module Menu (cont.)

Bottom	Side	Description
Create Limit Test template (cont.)	OK Store Template	Stores the template waveform defined by the source and ±V/H limit settings to the specified reference memory destination. The limit test template is not stored until you push this menu button.

